

Pyxis[®]

W A L C H E M

IWAKI America Inc.

ST-773 Dissolved Oxygen Sensor User Manual



Pyxis Lab[®] Inc.
1729 Majestic Drive Suite 05
Lafayette, Colorado 80026
www.pyxis-lab.com

ST-773 Dissolved Oxygen Sensor User Manual

March 18, 2022

Rev. 1.3

Pyxis Lab, Inc.

1729 Majestic Dr. Suite 5

Lafayette, CO 80026 USA

www.pyxis-lab.com

Table of Contents

1	Introduction	2
1.1	Main Features	3
2	Specifications	4
3	Unpacking Instrument	5
3.1	Standard Accessories	5
3.2	Optional Accessories	6
4	Installation	7
4.1	MA-150-1 Submersed Floating Installation	7
4.2	MA-120-B Submersed Fixed Installation	8
4.3	Pipeline Installation	9
4.4	Wiring	10
4.5	Connecting via Bluetooth	10
5	Setup and Calibration with uPyxis® Mobile App	11
5.1	Download uPyxis® Mobile App	11
5.2	Connecting to uPyxis® Mobile App	12
5.3	Calibration Screen and Reading	13
5.4	Diagnosis Screen	15
5.5	Device Info Screen	15
6	Setup and Calibration with uPyxis® Desktop App	16
6.1	Install uPyxis® Desktop App	16
6.2	Connecting to uPyxis® Desktop App	17
6.3	Information Screen	18
6.4	Calibration Screen	19
6.5	Diagnosis Screen	21
7	Outputs	21
7.1	4–20mA Output Setup	21
7.2	Adjusting 4–20mA Span	22
7.3	Communication using Modbus RTU	22
8	Sensor Maintenance and Precaution	23
8.1	Methods to Cleaning the ST-773 Sensor	23
8.2	Replace the DCC-06 Membrane Cartridge	24
8.3	Other Common Troubleshooting Issues	24
9	Contact Us	24

Warranty Information

Confidentiality

The information contained in this manual may be confidential and proprietary and is the property of Pyxis Lab, Inc. Information disclosed herein shall not be used to manufacture, construct, or otherwise reproduce the goods described. Information disclosed herein shall not be disclosed to others or made public in any manner without the express written consent of Pyxis Lab, Inc.

Standard Limited Warranty

Pyxis Lab warrants its products for defects in materials and workmanship. Pyxis Lab will, at its option, repair or replace instrument components that prove to be defective with new or remanufactured components (i.e., equivalent to new). The warranty set forth is exclusive and no other warranty, whether written or oral, is expressed or implied.

Warranty Term

The Pyxis warranty term is thirteen (13) months ex-works. In no event shall the standard limited warranty coverage extend beyond thirteen (13) months from original shipment date.

Warranty Service

Damaged or dysfunctional instruments may be returned to Pyxis for repair or replacement. In some instances, replacement instruments may be available for short duration loan or lease.

Pyxis warrants that any labor services provided shall conform to the reasonable standards of technical competency and performance effective at the time of delivery. All service interventions are to be reviewed and authorized as correct and complete at the completion of the service by a customer representative, or designate. Pyxis warrants these services for 30 days after the authorization and will correct any qualifying deficiency in labor provided that the labor service deficiency is exactly related to the originating event. No other remedy, other than the provision of labor services, may be applicable.

Repair components (parts and materials), but not consumables, provided during a repair, or purchased individually, are warranted for 90 days ex-works for materials and workmanship. In no event will the incorporation of a warranted repair component into an instrument extend the whole instrument's warranty beyond its original term.

Warranty Shipping

A Repair Authorization (RA) Number must be obtained from Pyxis Technical Support before any product can be returned to the factory. Pyxis will pay freight charges to ship replacement or repaired products to the customer. The customer shall pay freight charges for returning products to Pyxis. Any product returned to the factory without an RA number will be returned to the customer. To receive an RMA you can generate a request on our website at <https://pyxis-lab.com/request-tech-support/>.

Pyxis Technical Support

Contact Pyxis Technical Support at +1 (866) 203-8397, service@pyxis-lab.com, or by filling out a request for support at <https://pyxis-lab.com/request-tech-support/>.

1 Introduction

The Pyxis ST-773 optical luminescent dissolved oxygen (DO) sensor is based on the principle of ‘fluorescence quenching’ to determine the dissolved oxygen content in water. It incorporates Pyxis’ advanced technology in the field of fluorescence detection and uses dual Blue/Red light detection technology with excitation and reference light sources, offering a wide detection range and very low detection limit. The sensor also integrates a temperature sensor for compensation of the measurement of dissolved oxygen based on environmental conditions. The ST-773 offers an easily replaceable, front loading DO membrane cap that has been independently developed by Pyxis Lab, with a typical service life of up to two years. This unique DO membrane cap design incorporates a black microporous PTFE membrane material designed to provide extreme scratch resistance, extended life span and simple replacement. The flat front-end design of the ST-773 makes this platform less prone to contamination or fouling and is very easy to clean and brushable. The sensor body is composed of CPVC and is well suited for aggressive industrial application use. The ST-773 may be utilized in a submersed fixed/floating application or inline with the Pyxis submersion assembly and inline thread/tee accessory options. The ST-773 comes with a 10-meter bulkhead cable as well as 1.5-meter flying lead cable each with 7Pin quick adapters. The sensor output offers both 4-20mA and RS-485 Modbus communication which is Bluetooth enabled when used in conjunction with the MA-WB (7-Pin Bluetooth Adapter).

The ST-773 series measures the partial pressure of the dissolved oxygen (DO) in water. In most applications, the source of DO is oxygen in the air. In other application such as in aquaculture, the source of DO is photosynthesis. The concentration of dissolved oxygen is a derived value from the measured oxygen partial pressure. The relationship between the DO concentration and the oxygen partial pressure is governed by the law of thermodynamics. The ST-773 series uses the latest USGS equation to convert the oxygen partial pressure to DO in units of ppm or mg/L. Through setup using the **uPyxis**® Mobile or Desktop App, the ST-773 series sensor can output the measured oxygen partial pressure in other units such as percentage of oxygen saturation.

1.1 Main Features

The ST-773 sensor includes the following features:

- 0.004–20.0 mg/L measurement range
- Built-in temperature sensor with automatic compensation
- Accurate and stable measurement with ultra-low drift
- Built-in transmitter without preamplifier or meter head
- Dual Outputs both 4-20mA isolated signal or RS-485 Modbus (7-Pin Format)
- Long-distance transmission with higher stability & accuracy
- Wireless Calibration, Diagnostics and Trend via **uPyxis**® App when used with MA-WB Adapter
- The sensor can be Slope calibrated with air or air saturated water
- Zero-point calibration with 5% Sodium Sulfite solution or Nitrogen gas
- Suitable for dissolved oxygen monitoring of:
 - Activated Sludge
 - Aerated Basin
 - Wastewater & Sewage Processing
 - Chemical & Process Water
 - Domestic Water Applications
 - Filtration Applications
 - Aquaculture
 - Agriculture

2 Specifications

Table 1. ST-773 Specifications

Specification*	ST-773
Part Number (P/N)	53709
Body Material	CPVC
Installation Method	Submerged and Inline Installation
Measuring Range (4-20mA Output Scale)	0.004–20.0 mg/L or 0–200% Saturation
Resolution	0.01 mg/L
Accuracy	±0.3 mg/L or ±3%, whichever is greater
Response Time	<60 Seconds
Operational Temperature	0–45 °C (32–113 °F)
Signal Output	4-20mA analog output / RS-485 digital output
Dimension (L × D)	206 × 24.6 mm (8.11 × 0.97 inch)
Weight	188 g (0.41 lbs) cable excluded
Working Pressure	75 psi
Wet Material	CPVC and Polycarbonate
Cables Provided	1 x 4.9ft/1.5m Flying Lead Cable — 7Pin Female Adapter 1 x 30ft/15m Bulkhead Cable — 7Pin Male Adapter <i>(Interconnecting Extension Cables Purchased Separately)</i>
Calibration	Slope calibration Air or Air Saturated Water Zero calibration: 5% Sodium Sulfite or Nitrogen Gas
DO Membrane Cap Life	1.5 years
Protection Grade	IP-67
Regulation	CE / RoHS
Compliance	USEPA 40CFR Part 136.3 / ISO 17289:2014

* With Pyxis’s continuous improvement policy, these specifications are subject to change without notice.

3 Unpacking Instrument

Remove the instrument and accessories from the shipping container and inspect each item for any damage that may have occurred during shipping. Verify that all accessory items are included. If any item is missing or damaged, please contact Pyxis Lab Customer Service at service@pyxis-lab.com.

3.1 Standard Accessories

ST-773 Shipped with Standard Accessories (P/N 53709)

The following accessories are included in the ST-773 probe for submersed or inline installations. Please note submersion or inline adapters are purchased separately. Please see optional accessories for details.

- One ST-773 Dissolved Oxygen Probe w 30ft/10m Bulkhead Cable (Male Adapter-7Pin)
- One DCC-6 DO Membrane Cap for ST-773
- One MA-1100 1.5 Meter/ 4.9 ft Cable (Female Adapter/Flying Lead-7Pin)
- One MA-WB Bluetooth Adapter for 7Pin Sensors
- One MA-NEB Bluetooth/USB Adapter for use with Desktop uPyxis APP
- User Manual available online at <https://pyxis-lab.com/support/>



Figure 1.

ST-773 / MA-1100 Flying Lead / MA-WB Bluetooth Adapter / MA-NEB USB Adapter / DCC-6 Membrane Cap]

3.2 Optional Accessories

The following optional accessories can be ordered from Pyxis Customer Service (order@pyxis-lab.com) or Pyxis E-Store at <https://pyxis-lab.com/shop/>.

Table 2. Optional Accessories

Optional / Replacement Accessories	Part Number (P/N)
MA-WB Bluetooth Adapter for 7-Pin Pyxis Sensors	MA-WB
MA-150-1 Floating Submersion Adapter Kit	53705
MA-120-B Fixed Submersion Adapter Kit	50783
ST-773 Threaded Adapter for Inline Installation (1 inch NPT)	50700-A04
ST-001 and Collar Tee Assembly for Non-Threaded Inline Installation (3/4 inch NPT)	53726
DCC-6 Dissolved Oxygen Membrane Cap — Replacement	53723
MA-C50 (50' Extension Cable w/7Pin Adapters)	50705
MA-C100 (100' Extension Cable w/7Pin Adapters)	50706

4 Installation

4.1 MA-150-1 Submersed Floating Installation

The ST-773 may be installed in a submersed/floating application using the MA-150-1 Submersed Floating Adapter Kit. This kit contains a swiveling conduit mounting bracket and ball float-probe adapter assembly in 1-inch FNPT. (Please note the ST773 outer diameter is 3/4 - inch NPT. A 3/4 to 1-inch NPT bushing is required for installation) The ST-773 dissolved oxygen sensor needs to be installed as shown in Figure 2. For installation, users only need to purchase the MA-150-1 from Pyxis Lab and may obtain water-tight conduit and cable seal adapter from their supplier of choice. For sensor replacement and maintenance, users only need to pull the MA-150-1 and DO sensor from fixing bracket vertically (upward).

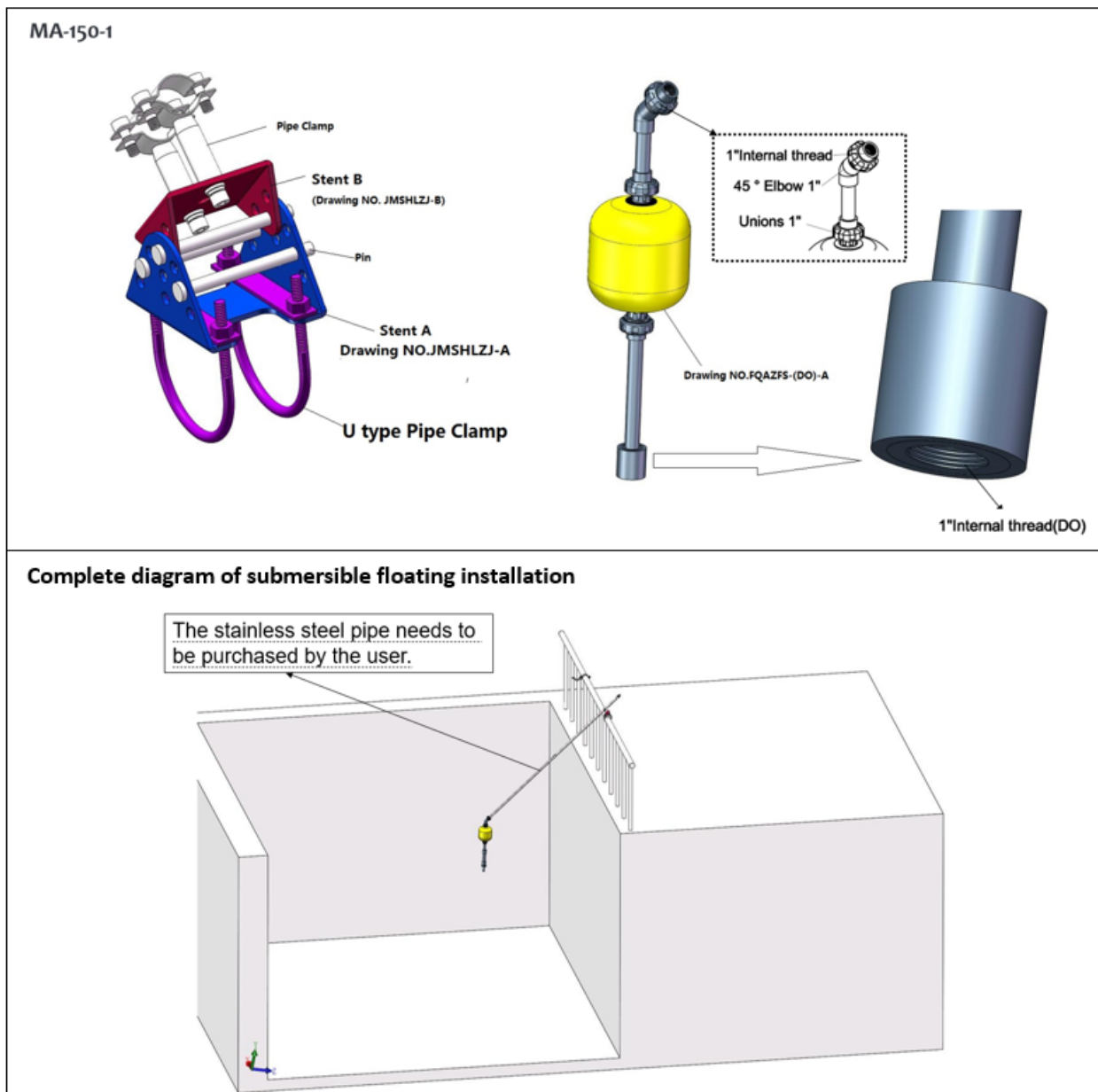

Figure 2. ST-773 in a submersed floating installation

4.2 MA-120-B Submersed Fixed Installation

The ST-773 may be installed in a submersed/fixd application using the MA-120-B Submersion Adapter Mounting Bracket and probe adapter coupler in 1-inch FNPT. *(Please note the ST773 outer diameter is 3/4 - inch NPT. A 3/4 to 1-inch NPT bushing is required for installation)* The ST-773 dissolved oxygen sensor needs to be installed as shown in Figure 3. For installation, users only need to purchase the MA-120-B from Pyxis Lab and may obtain water-tight conduit and cable seal adapter from their supplier of choice. For sensor replacement and maintenance, users only need to pull the MA-120-B and DO sensor from fixing bracket vertically (upwards).

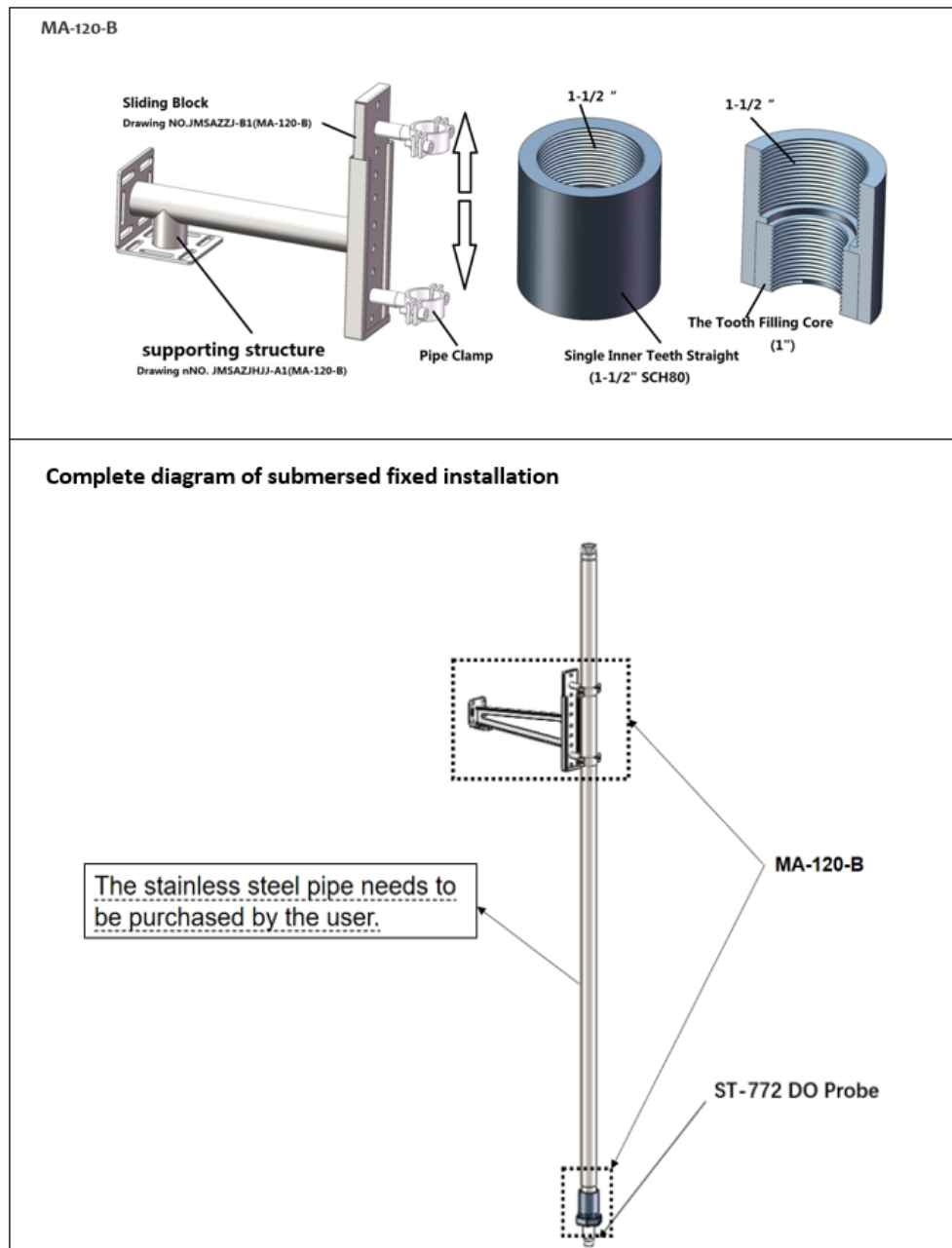
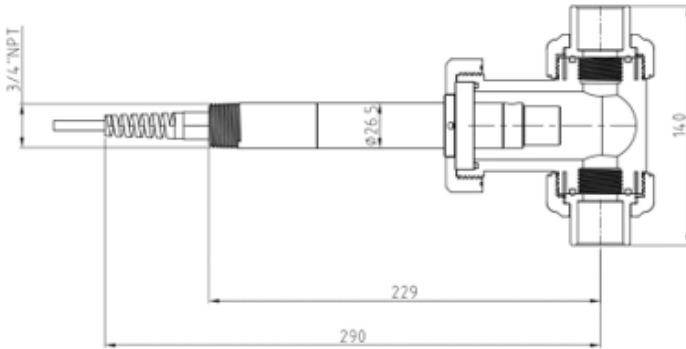

Figure 3. ST-773 in a submersed fixed installation

4.3 Pipeline Installation

The ST-773 may be installed in a pressurized inline flow application as high as 75 psi (5Bar) using optional accessories (Pyxis ST-001/Collar Kit or ST-771 1-inch Threaded Adapter Kit). Pyxis recommends installation in a vertical flow format from bottom up to reduce the impact of air bubbles. Install the probe collar on the sensor and then install the sensor into the ST-001 tee assembly and ensure the DCC-6 membrane cap is in the direction of water flow as shown in Figure 4.

BELOW - Inline installation using ST-001 Tee Assembly and Sensor Collar Kit



BELOW - Inline installation using optional 1-inch Threaded Adapter Kit

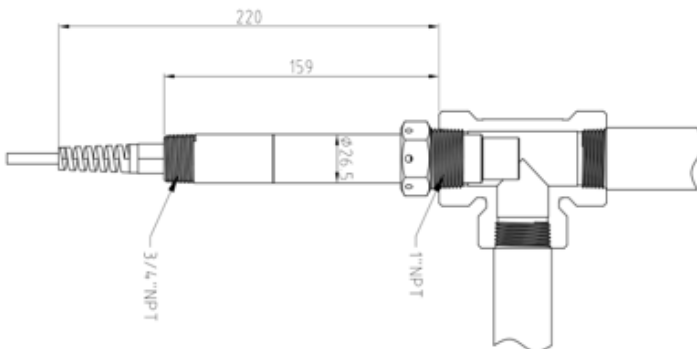

Figure 4. ST-773 in a pipeline installation using optional ST-001 Tee Assembly Kit (P/N -53726) or 1-inch Thread Adapter Kit (50700-A04)

4.4 Wiring

If the power ground terminal and the negative 4–20mA terminal in the controller are internally connected (non-isolated 4–20mA input), it is unnecessary to connect the 4–20mA negative wire (green) to the 4–20mA negative terminal in the controller. If a separate DC power supply other than that from the controller is used, make sure that the output from the power supply is rated for 22–26 VDC @ 65 mA.

NOTE *The negative 24V power terminal (power ground) and the negative 4–20mA terminal on the ST-773 sensor are internally connected.*

Follow the wiring table below to connect the ST-773 sensor to a controller:

Table 3.

Wire Color	Designation
Red	24V +
Black	24V Power ground
Green*	4–20mA -
White	4–20mA +
Blue	RS-485 A
Yellow	RS-485 B
Silver	GNDD

* Internally connected to the power ground

4.5 Connecting via Bluetooth

A Bluetooth adapter (P/N: MA-WB) can be used to connect a ST-773 sensor to a smart phone with the **uPyxis®** Mobile App or a computer with a Bluetooth/USB Adapter (P/N: MA-NEB) and the **uPyxis®** Desktop App.

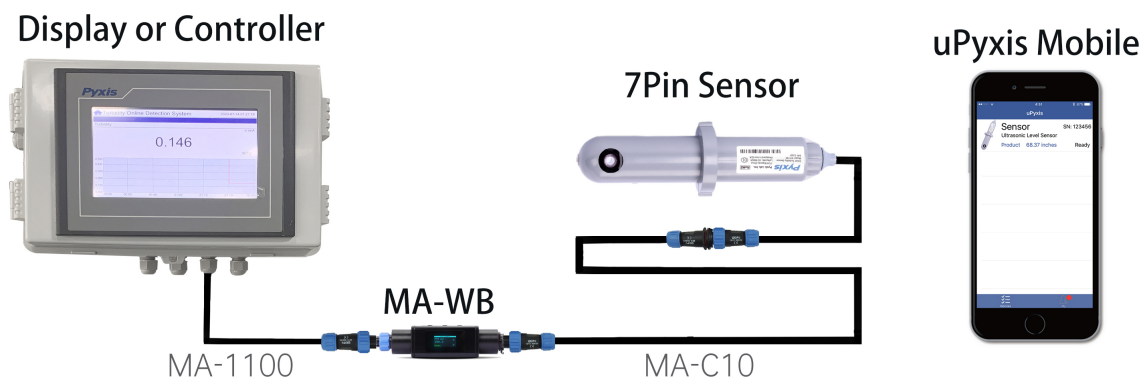

Figure 5. Bluetooth connection to ST-773 sensor

5 Setup and Calibration with uPyxis® Mobile App

5.1 Download uPyxis® Mobile App

Download uPyxis® Mobile App from [Apple App Store](#) or [Google Play](#).



Figure 6. uPyxis® Mobile App installation

5.2 Connecting to uPyxis® Mobile App

Connect the ST-773 sensor to a mobile smart phone according to the following steps:

1. Open **uPyxis®** Mobile App.
2. On **uPyxis®** Mobile App, pull down to refresh the list of available Pyxis devices.
3. If the connection is successful, the ST-773 and its Serial Number (SN) will be displayed (Figure 7).
4. Press on the **ST-773 sensor image**.



Figure 7.

5.3 Calibration Screen and Reading

When connected, the uPyxis® Mobile App will default to the **Calibration** screen. From the **Calibration** screen, you can perform calibrations by pressing on **Zero Calibration**, **Air Calibration**, and **4–20mA Span**.

NOTE Before calibrating, remove the ST-773 sensor from the water and wipe it with a damp cloth to remove debris and any biofouling. If there is water on the membrane, dry it with a soft cloth, taking special care not to damage the membrane.

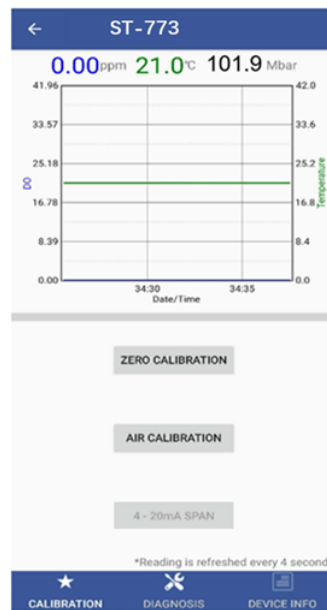

Figure 8.

5.3.1 Zero Calibration

1. Place the sensor in Nitrogen Gas or 5% Sodium Sulfite solution (anaerobic water).
2. Let the ST-773 sensor stand for a minimum of 15 minutes. Observe the values being displayed on the **Calibration** screen.
3. Once the displayed oxygen and temperature values are stable, press **Zero Calibration** to perform a zero calibration.
4. If the calibration is successful, the interface will return a message "Calibration Succeeded". If the calibration fails, press **Zero Calibration** again and repeat.

5.3.2 Air (Slope) Calibration

1. Place the ST-773 sensor in the air with a stable temperature or in air-saturated water.
2. Let the ST-773 sensor stand for a minimum of 6 minutes. Observe the values being displayed on the **Calibration** screen.
3. Once the displayed oxygen and temperature values are stable, press **Air Calibration** to perform an air (slope) calibration.
4. Enter the local, real-time atmospheric pressure value in mbar. If a value is not entered the sensor will default to 101.1 mbar.
5. Enter the humidity value:
 - If you are using air for calibration, you will need to enter the real-time (current) humidity value.
 - If you are using air-saturated water for calibration, you will need to enter a humidity value of "1".
6. If the air (slope) calibration was successful, the interface will return a message "Calibration Succeeded". If the calibration fails, press **Air Calibration** again and repeat.

5.4 Diagnosis Screen

From the **Diagnosis** screen, you can check the diagnosis condition as well as **Export & Upload**. This feature may be used for technical support when communicating with service@pyxis-lab.com.

To perform a Cleanliness and Selflife Check, first select the **Diagnosis Condition** which defines the fluid type that the ST-773 sensor is currently measuring, then press **Cleanliness and Selflife Check**. If the sensor is clean, a **Clean** message will be shown. If the sensor is severely fouled, a **Please replace the DO membrane cap** message will be shown. In this case, follow the procedure in the **Methods to Cleaning the ST-773 Sensor** section of this manual.

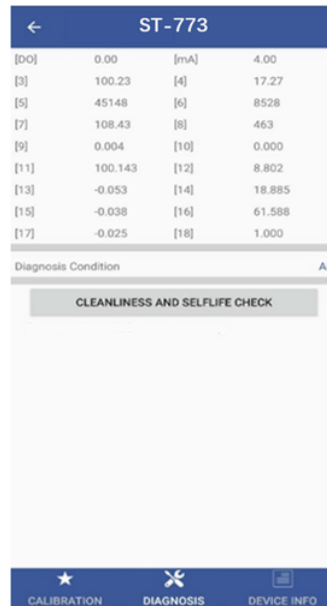

The screenshot shows the ST-773 Diagnosis screen. At the top, there is a back arrow and the title 'ST-773'. Below this is a table of sensor data. The table has two columns of data. Below the table, there is a 'Diagnosis Condition' dropdown menu set to 'Air'. A large button labeled 'CLEANLINESS AND SELFLIFE CHECK' is centered on the screen. At the bottom, there is a navigation bar with three icons: a star for 'CALIBRATION', a wrench for 'DIAGNOSIS', and a document for 'DEVICE INFO'.

[00]	0.00	[mA]	4.00
[3]	100.23	[4]	17.27
[5]	45148	[6]	8528
[7]	108.43	[8]	463
[9]	0.004	[10]	0.000
[11]	100.143	[12]	8.802
[13]	-0.053	[14]	18.885
[15]	-0.038	[16]	61.588
[17]	-0.025	[18]	1.000

Diagnosis Condition: Air

CLEANLINESS AND SELFLIFE CHECK

CALIBRATION DIAGNOSIS DEVICE INFO

Figure 9.

5.5 Device Info Screen

From the **Device Info** screen. You can name the Device or Product as well as set the Modbus address.

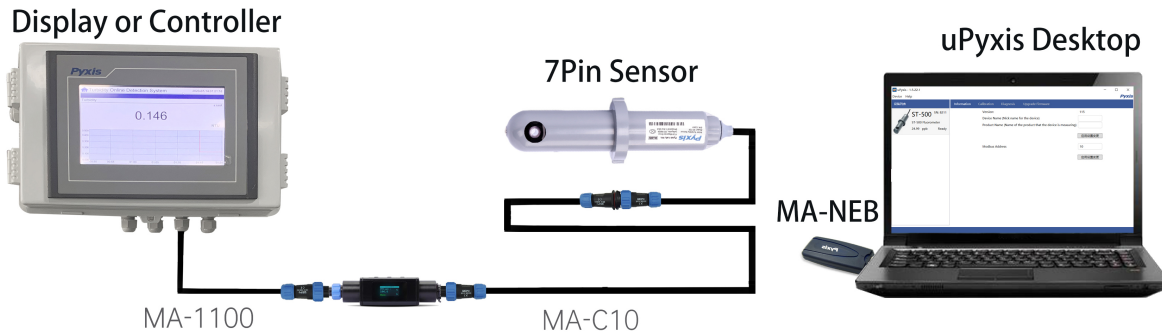

Figure 10. Bluetooth connection to ST-773 sensor with MA-WB, MA-NEB and uPyxis Desktop App.

6 Setup and Calibration with uPyxis® Desktop App

6.1 Install uPyxis® Desktop App

Download the latest version of uPyxis® Desktop software package from: <https://pyxis-lab.com/upyxis/> this setup package will download and install the Microsoft.Net Framework 4.5 (if not previously installed on the PC), the USB driver for the USB-Bluetooth adapter (MA-NEB), the USB-RS485 adapter (MA-485), and the main uPyxis® Desktop application. Double click the **uPyxis.Setup.exe** file to install.

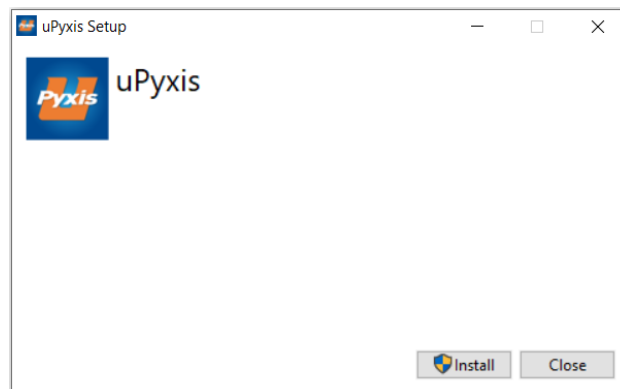

Figure 11. uPyxis® Desktop App installation

Click **Install** to start the installation process. Follow the screen instructions to complete the USB driver and uPyxis® installation.

6.2 Connecting to uPyxis® Desktop App

Connect the ST-773 sensor to a Windows computer using a Bluetooth/USB adapter (P/N: MA-NEB) according to the following steps:

1. Plug the Bluetooth/USB adapter into a USB port in the computer.
2. Launch uPyxis® Desktop App.
3. On uPyxis® Desktop App, click Device→ **Connect via USB-Bluetooth** (Figure 12).
4. If the connection is successful, the ST-773 and its Serial Number (SN) will be displayed in the left pane of the uPyxis® window.

NOTE After the sensor and Bluetooth is powered up, it may take up to 10 seconds for the adapter to establish the wireless signal for communication.

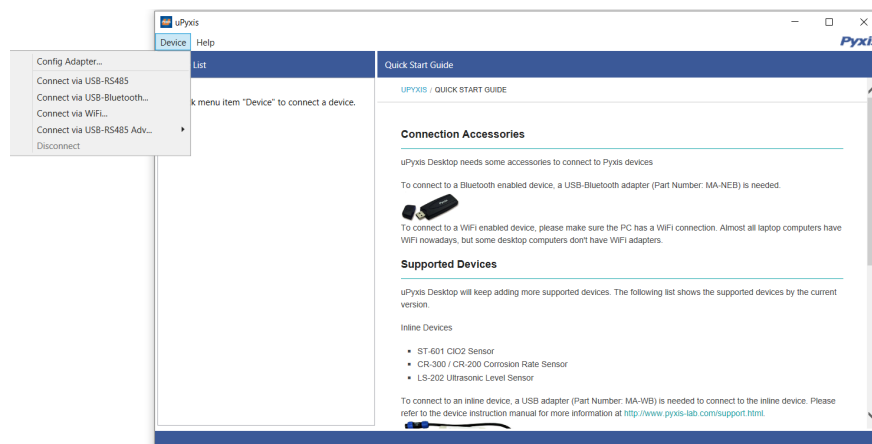

Figure 12.

6.3 Information Screen

Once connected to the device, a picture of the device will appear on the top left corner of the window and the uPyxis® Desktop App will default to the **Information** screen. On the **Information** screen you can set the information description for **Device Name**, **Product Name**, and **Modbus Address**, then click **Apply Settings** to save.

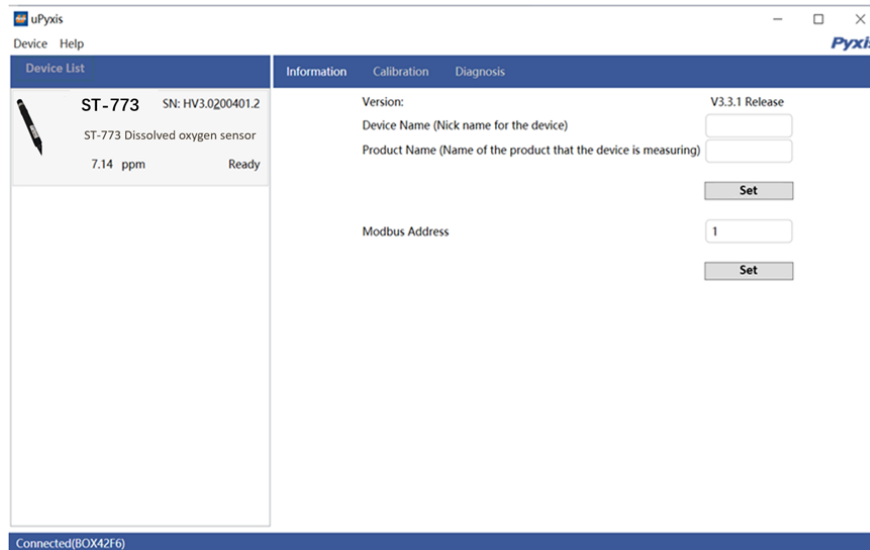

Figure 13.

6.4 Calibration Screen

From the **Calibration** screen, you can perform calibrations by pressing on **Zero Calibration**, **Air Calibration**, and **4–20mA Span**.

NOTE Before calibrating, remove the ST-773 sensor from the water and wipe it with a damp cloth to remove debris and any biofouling. If there is water on the membrane, dry it with a soft cloth, taking special care not to damage the membrane.

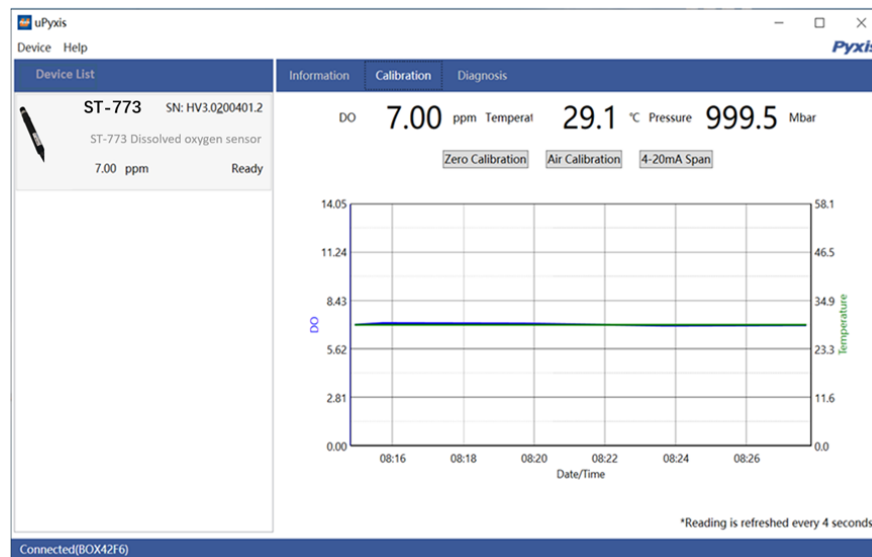

Figure 14.

6.4.1 Zero Calibration

1. Place the sensor in Nitrogen Gas or 5% Sodium Sulfite solution (anaerobic water).
2. Let the ST-773 sensor stand for a minimum of 15 minutes. Observe the values being displayed on the **Calibration** screen.
3. Once the displayed oxygen and temperature values are stable, click **Zero Calibration** to perform a zero calibration.
4. If the calibration is successful, the interface will return a message "Calibration Succeeded". If the calibration fails, click **Zero Calibration** again and repeat.

6.4.2 Air (Slope) Calibration

1. Place the ST-773 sensor in the air with a stable temperature or in air-saturated water.
2. Let the ST-773 sensor stand for a minimum of 6 minutes. Observe the values being displayed on the **Calibration** screen.
3. Once the displayed oxygen and temperature values are stable, click **Air Calibration** to perform an air (slope) calibration.
4. Enter the local, real-time atmospheric pressure value in mbar. If a value is not entered the sensor will default to 101.1 mbar.
5. Enter the humidity value:
 - If you are using air for calibration, you will need to enter the real-time (current) humidity value.
 - If you are using air-saturated water for calibration, you will need to enter a humidity value of "1".
6. If the air (slope) calibration was successful, the interface will return a message "Calibration Succeeded". If the calibration fails, click **Air Calibration** again and repeat.

6.5 Diagnosis Screen

After the device has been calibrated and installation has been completed, to check diagnosis, click on **Diagnosis**. When in the **Diagnosis** screen you can view the Diagnosis Condition of the device. This feature may be used for technical support when communicating with service@pyxis-lab.com. To perform a Cleanliness and Selflife Check, first select the **Diagnosis Condition** which defines the fluid type that the ST-773 sensor is currently measuring, then click **Cleanliness and Selflife Check**. If the sensor is clean, a **Clean** message will be shown. If the sensor is fouled, a **Please replace the DO membrane cap** message will be shown. In this case, follow the procedure in the **Methods to Cleaning the ST-773** section of this manual.

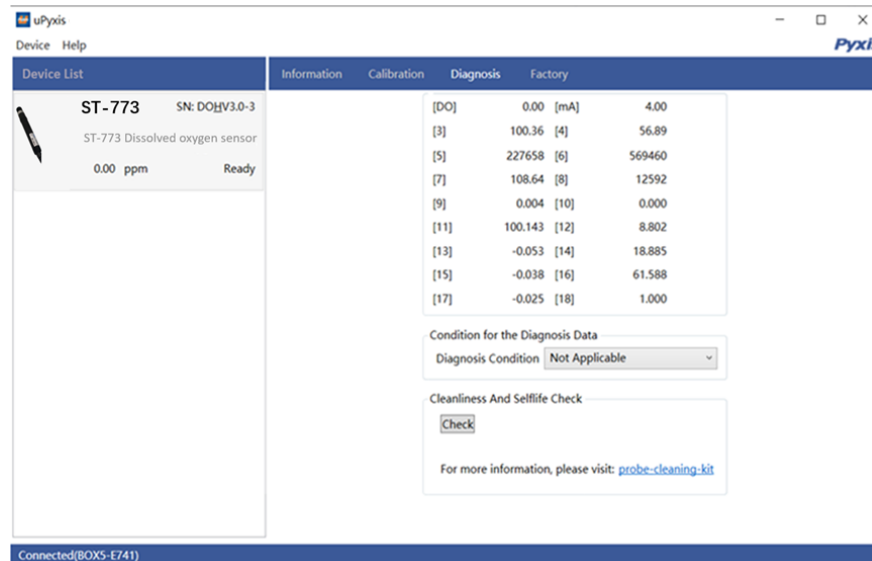

Figure 15.

7 Outputs

7.1 4–20mA Output Setup

The 4–20mA output of the ST-773 sensor is scaled as:

- Dissolved Oxygen:
 - 4 mA = 0 ppm
 - 20 mA = 20 ppm

7.2 Adjusting 4–20mA Span

Users may adjust the output scale using 4–20mA Span to change the dissolved oxygen ppm value corresponding to the 20 mA output via uPyxis®. For the uPyxis® Mobile App, press **4-20mA Span** found on the **Calibration and Reading Screen**, shown in Figure 16. For the uPyxis® Desktop App, click **4-20mA Span** found on the **Calibration Screen**, shown in Figure 17.

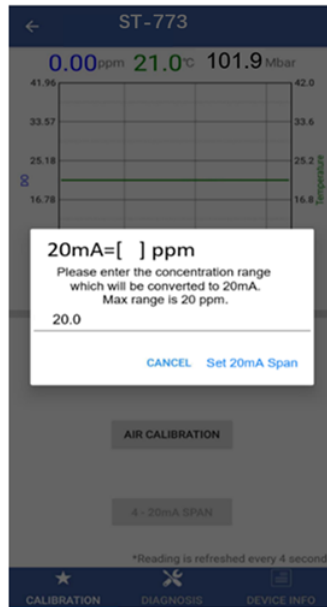

Figure 16.



Figure 17.

7.3 Communication using Modbus RTU

The ST-773 sensor is configured as a Modbus slave device. In addition to the dissolved oxygen ppm value, many operational parameters, including warning and error messages, are available via a Modbus RTU connection. Contact Pyxis Lab Customer Service (service@pyxis-lab.com) for more information.

8 Sensor Maintenance and Precaution

The ST-773 sensor is designed to provide reliable and continuous dissolved oxygen readings even when installed in moderately contaminated industrial waters. Although the optics are compensated for the effects of moderate fouling, heavy fouling will prevent the light from reaching the sensor, resulting in low readings and the potential for product overfeed if the ST-773 sensor is used as part of an automated control system. When used to control product dosing, it is suggested that the automation system be configured to provide backup to limit potential product overfeed, for example by limiting pump size or duration, or by alarming if the pumping rate exceeds a desired maximum limit.

The ST-773 sensor is designed to be easily removed, inspected, and cleaned if required. It is suggested that the ST-773 sensor be checked for fouling and cleaned/calibrated on a monthly basis. Heavily contaminated waters may require more frequent cleanings. Cleaner water sources with less contamination may not require cleaning for several months. The need to clean the ST-773 sensor can be determined by the **Cleanliness and Selflife Check** using either the **uPyxis®** Mobile App (see the **Mobile Diagnosis Screen** section) or the **uPyxis®** Desktop App (see the **Desktop Diagnosis Screen** section). If the **Cleanliness and Selflife Check** continues to return a **Please replace the DO membrane cap**, use an Allen wrench to remove the protective cover, unscrew the current membrane cap, check whether the inside of the ST-773 sensor flashes blue and red light, then screw on a new membrane cap and re-fasten the protective cover.

8.1 Methods to Cleaning the ST-773 Sensor

Any equipment in contact with industrial cooling systems is subject to many potential foulants and contaminants. Our inline sensor cleaning solutions below have been shown to remove most common foulants and contaminants. The surface of the DCC-6 Dissolved Oxygen Membrane Cap can be cleaned with a cotton swab. Please do not use sharp instruments to clean the membrane cap. In addition, the Pyxis Inline Probe Cleaning Solution Kit may also be used to removal of heavy deposits, especially inorganics, and can be purchased at our online E-Store <https://pyxis-lab.com/product/probe-cleaning-kit/>.



Figure 18. Inline Probe Cleaning Solution Kit

To clean the ST-773 sensor, remove the sensor and the DO membrane cap from the water in use, wipe it with a damp cloth to remove debris and growing organisms, and use a cotton swab dipped in water to clean up the dirt on the membrane surface. Unscrew the membrane cap, check whether the inside of the ST-773 sensor flashes blue and red light; after the inspection, screw the DO membrane cap back onto the sensor.

8.2 Replace the DCC-06 Membrane Cartridge

For best performance and accuracy, please replace the DCC-06 membrane cartridge:

- Every two years
- If the membrane cartridge is faulty or damaged.
The instructions for replacing the DCC-06 membrane cartridge are given below.
- Remove the membrane DCC-06 cartridge that needs to be replaced, and carefully screw on the new membrane cartridge clockwise (until snugly hand tightened so cap can no longer tighten).
- Please refer to Section 4.0 to perform zero calibration and air calibration respectively if desired.

8.3 Other Common Troubleshooting Issues

If the ST-773 sensor output signal is not stable and fluctuates significantly, make an additional ground connection — connect the clear (GNDD) wire to a conductor that contacts the sample water electrically such as a metal pipe adjacent to the ST-773 tee.

10 Contact Us

Pyxis Lab, Inc

1729 Majestic Dr. Suite 5

Lafayette, CO 80026 USA

www.pyxis-lab.com

Phone: +1 (866) 203-8397

Email: service@pyxis-lab.com